

1060307

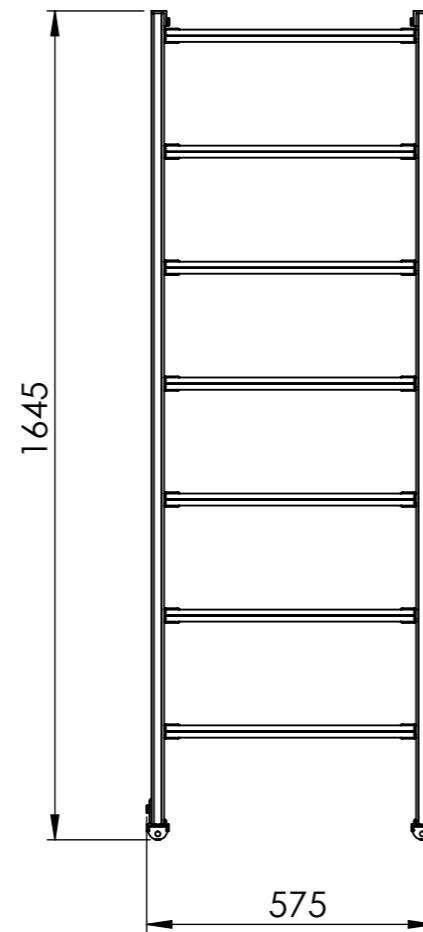
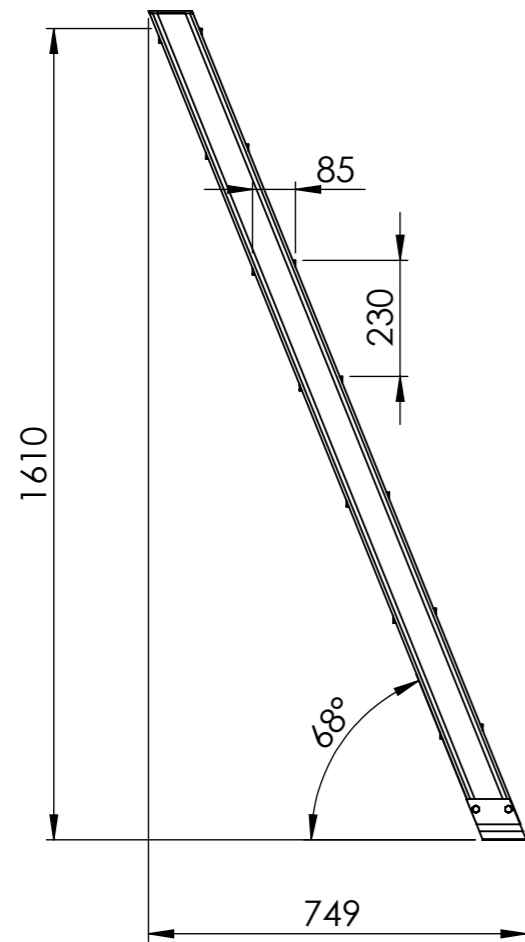
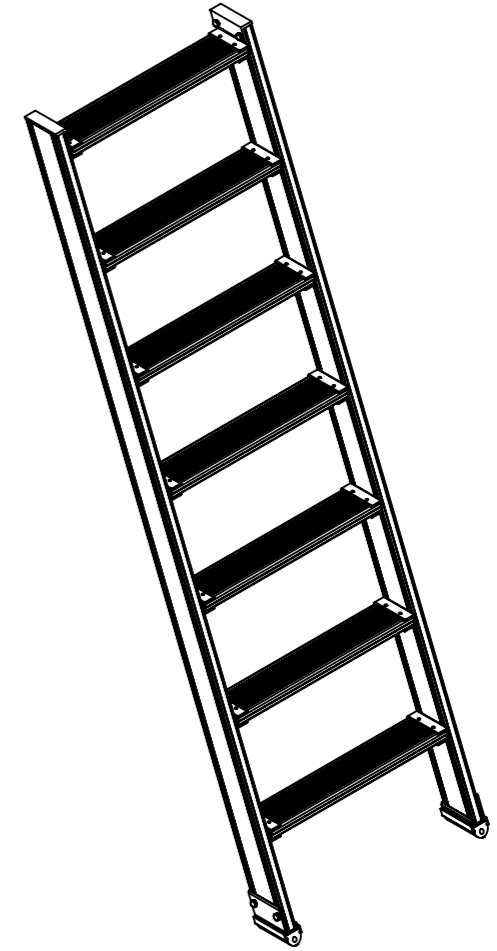
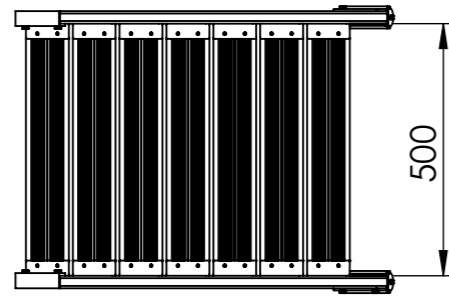

8 kg

ESLA