

1060106

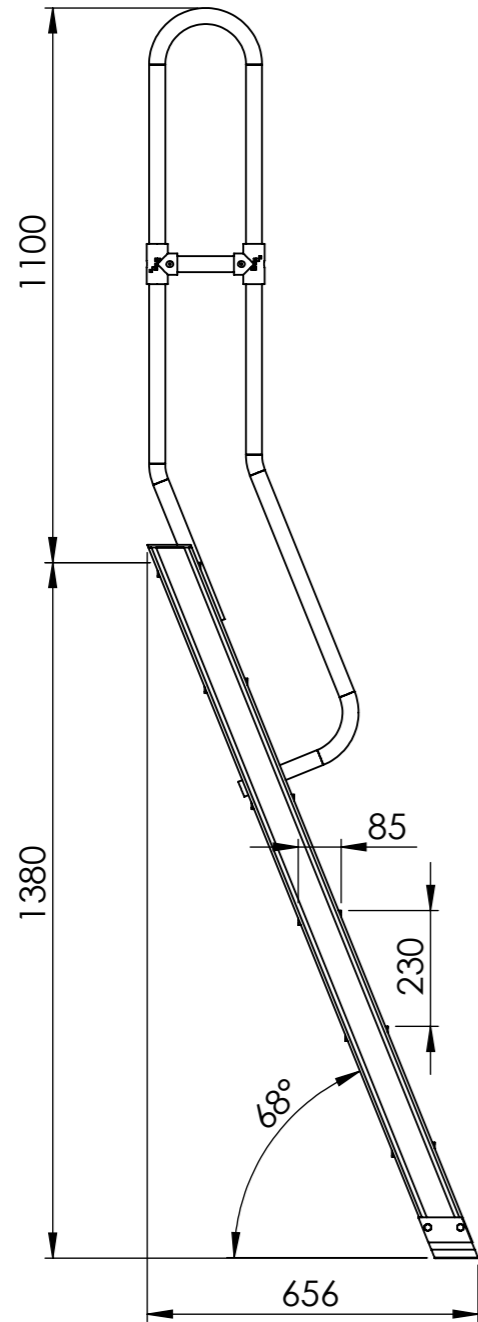

9 kg

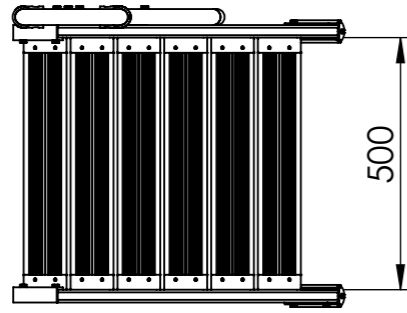
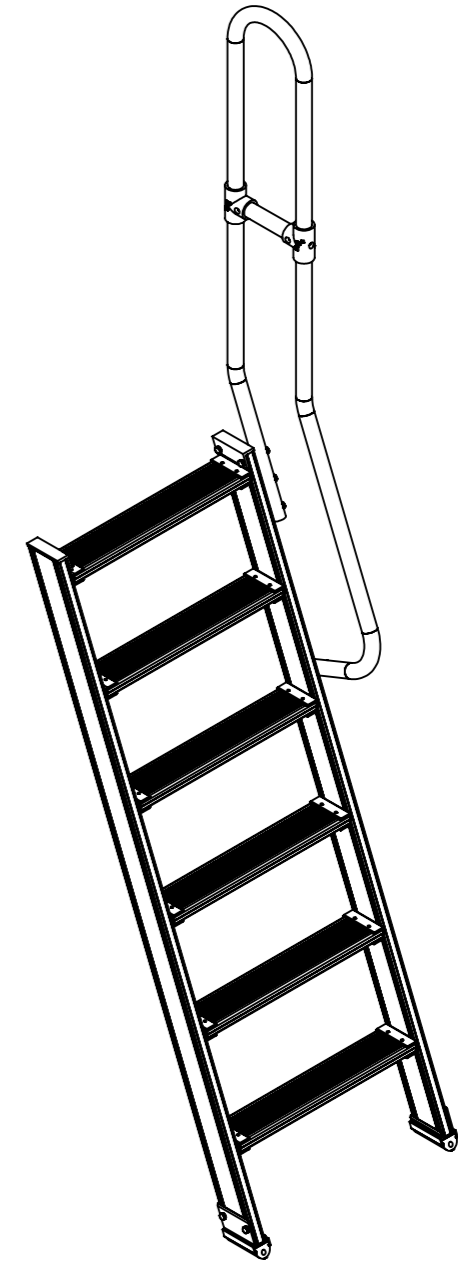
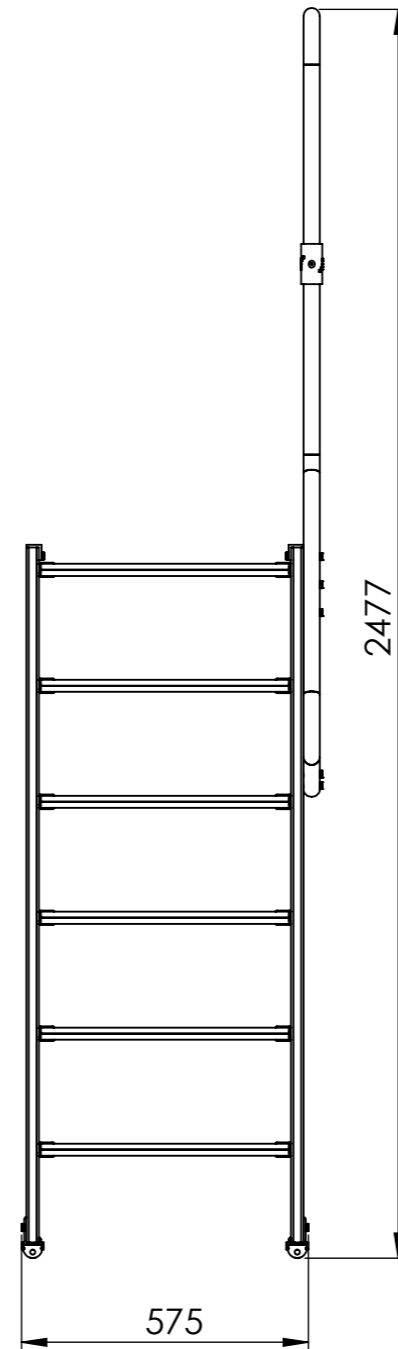

ESLA

1060106

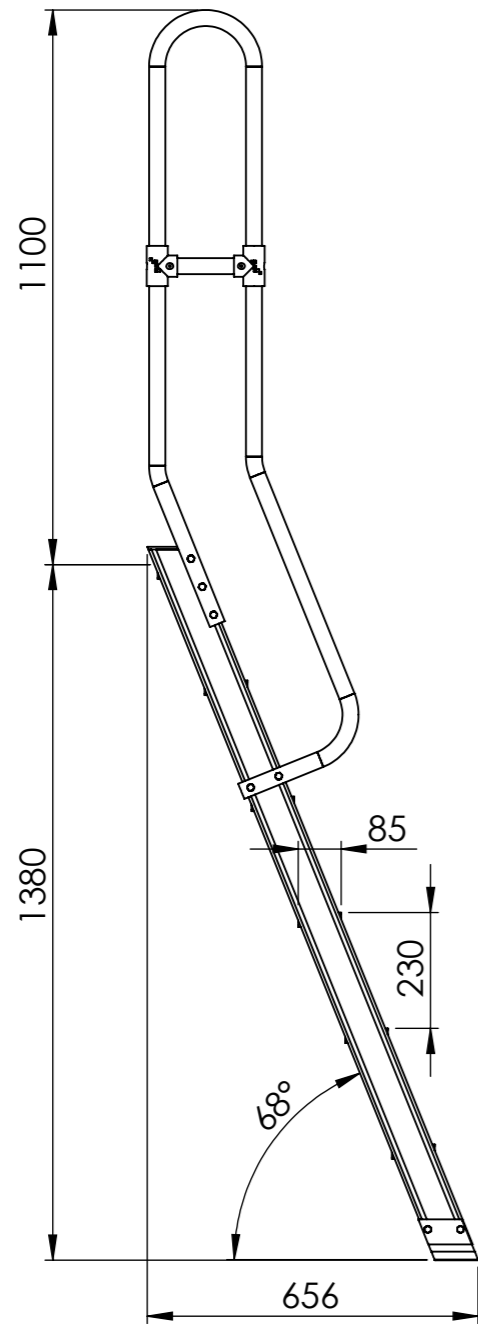
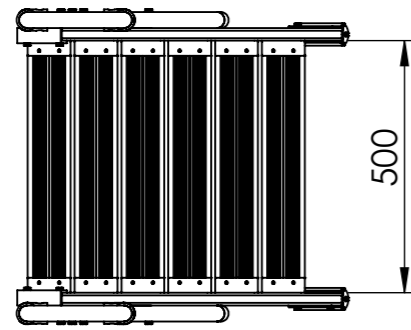

12 kg

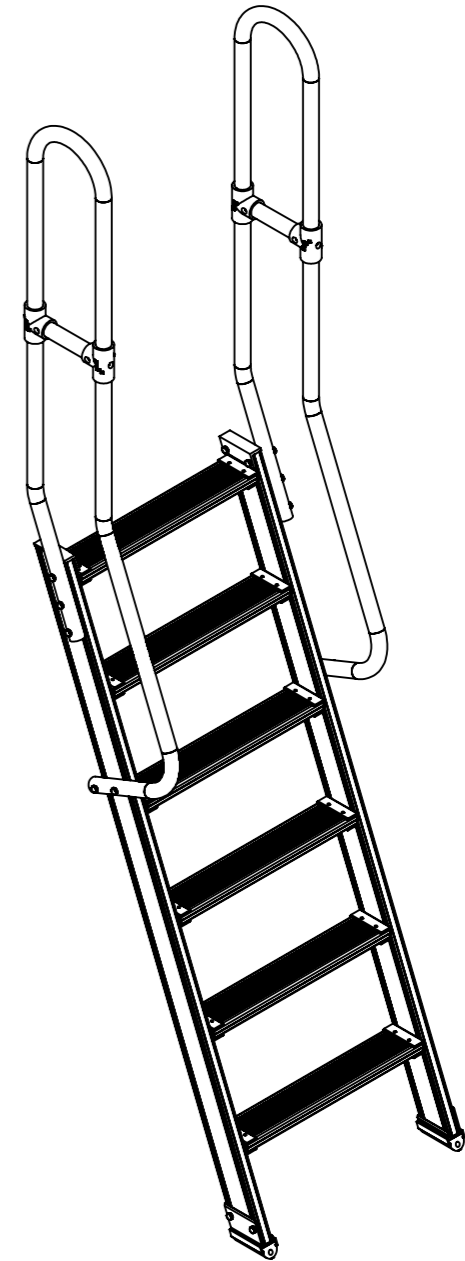
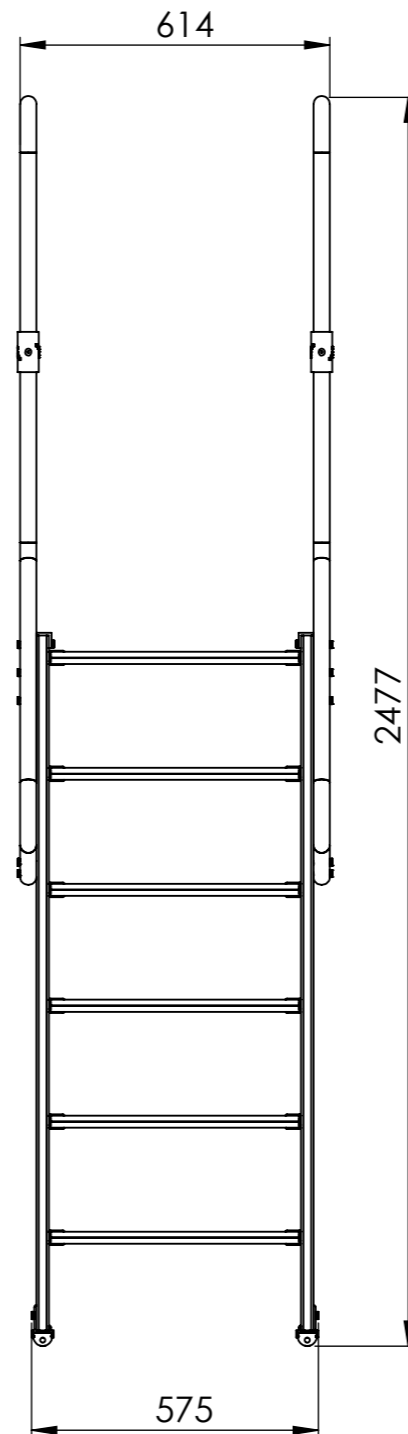

ESLA