

1010516

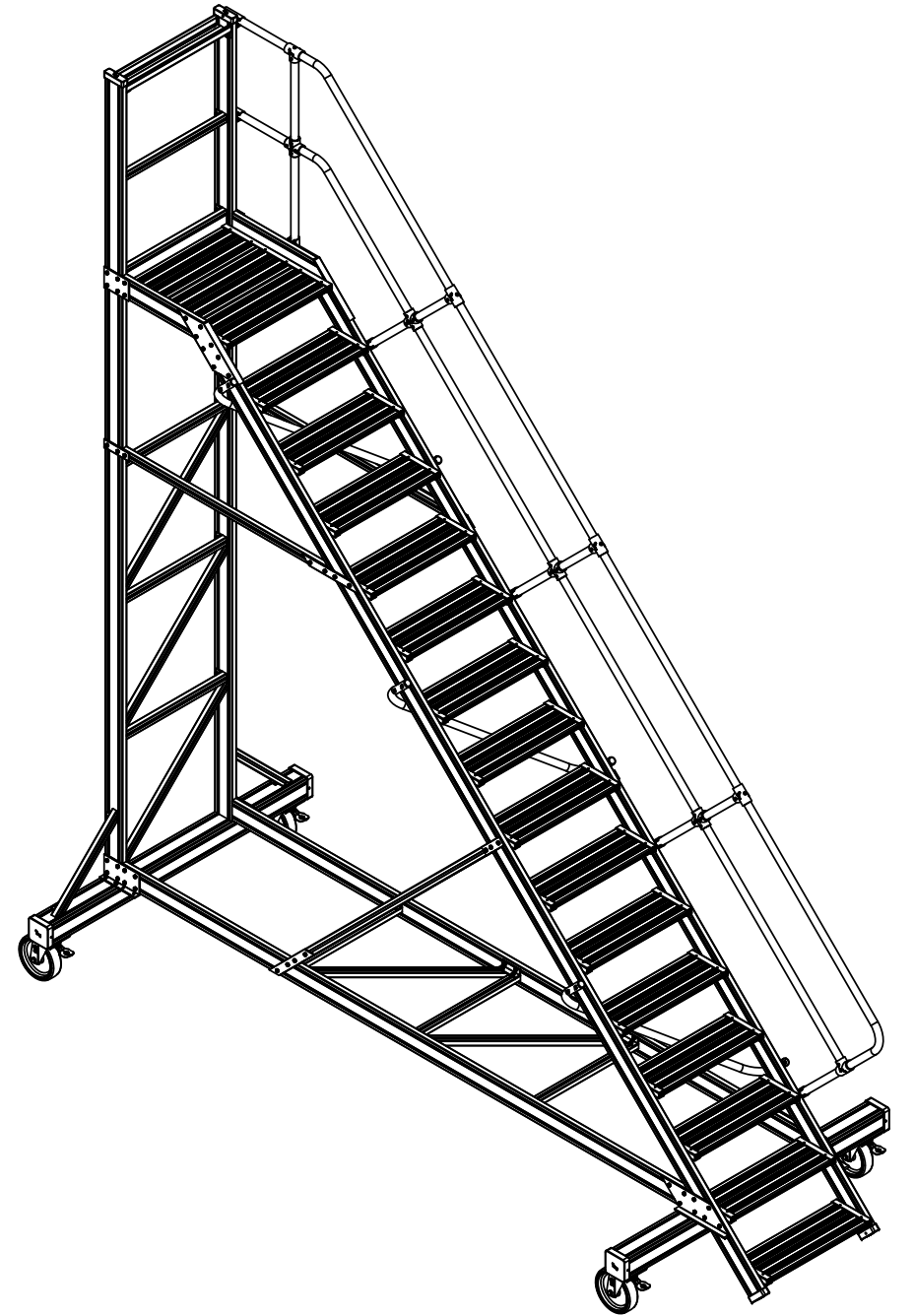
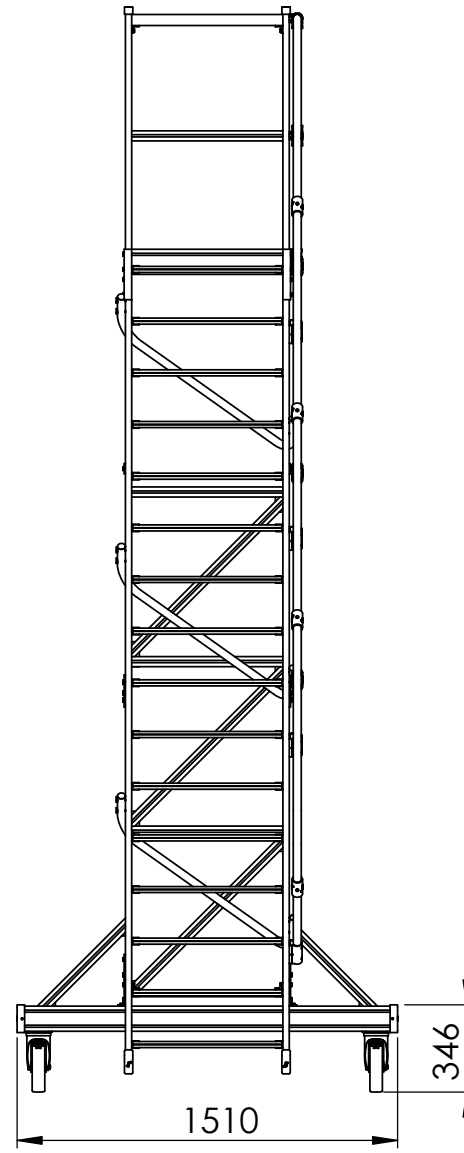
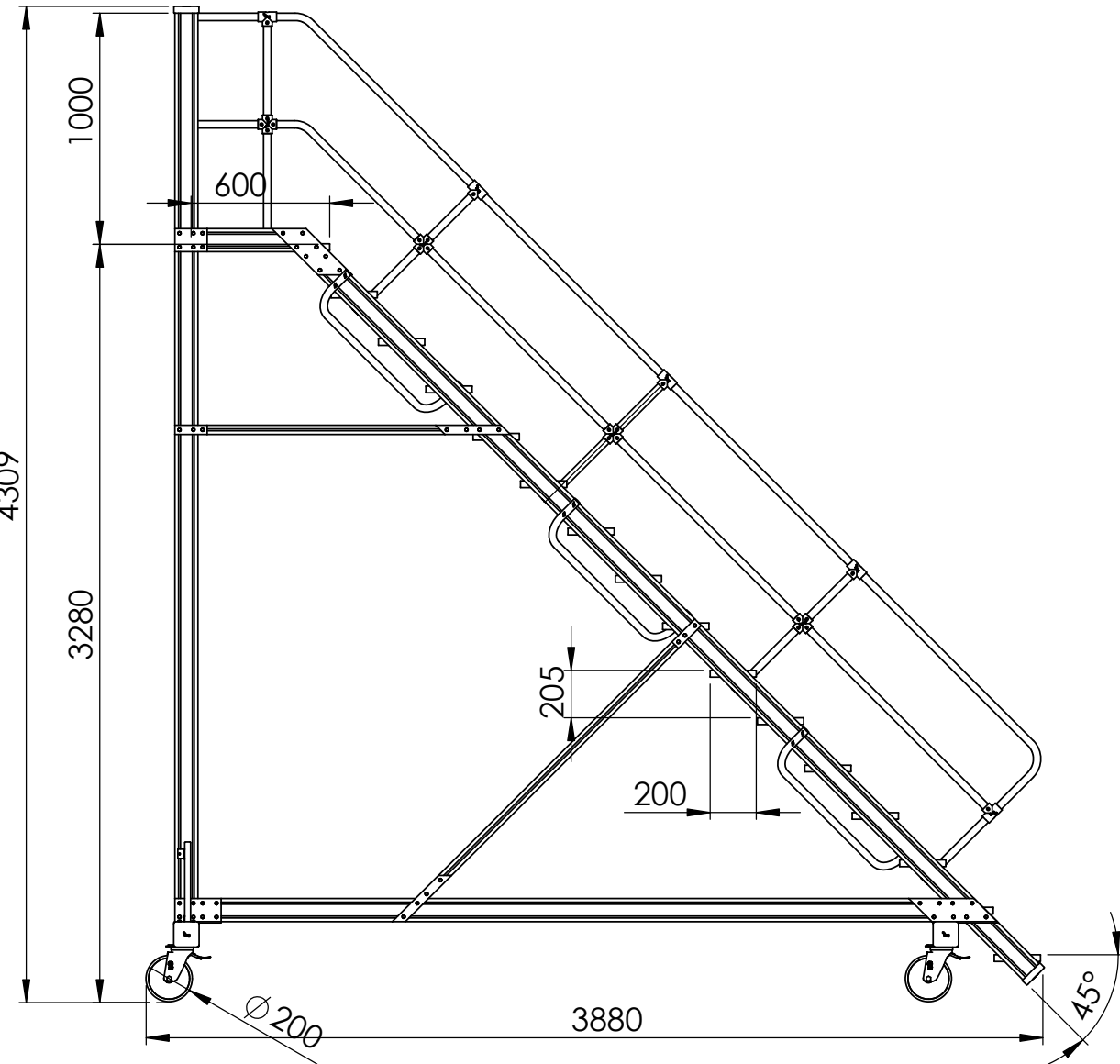
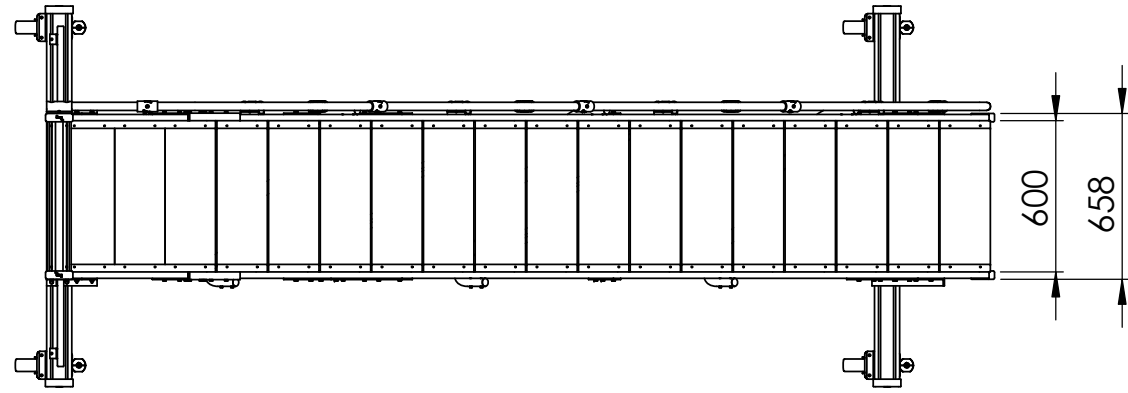

105 Kg

ESLA

1010516DB

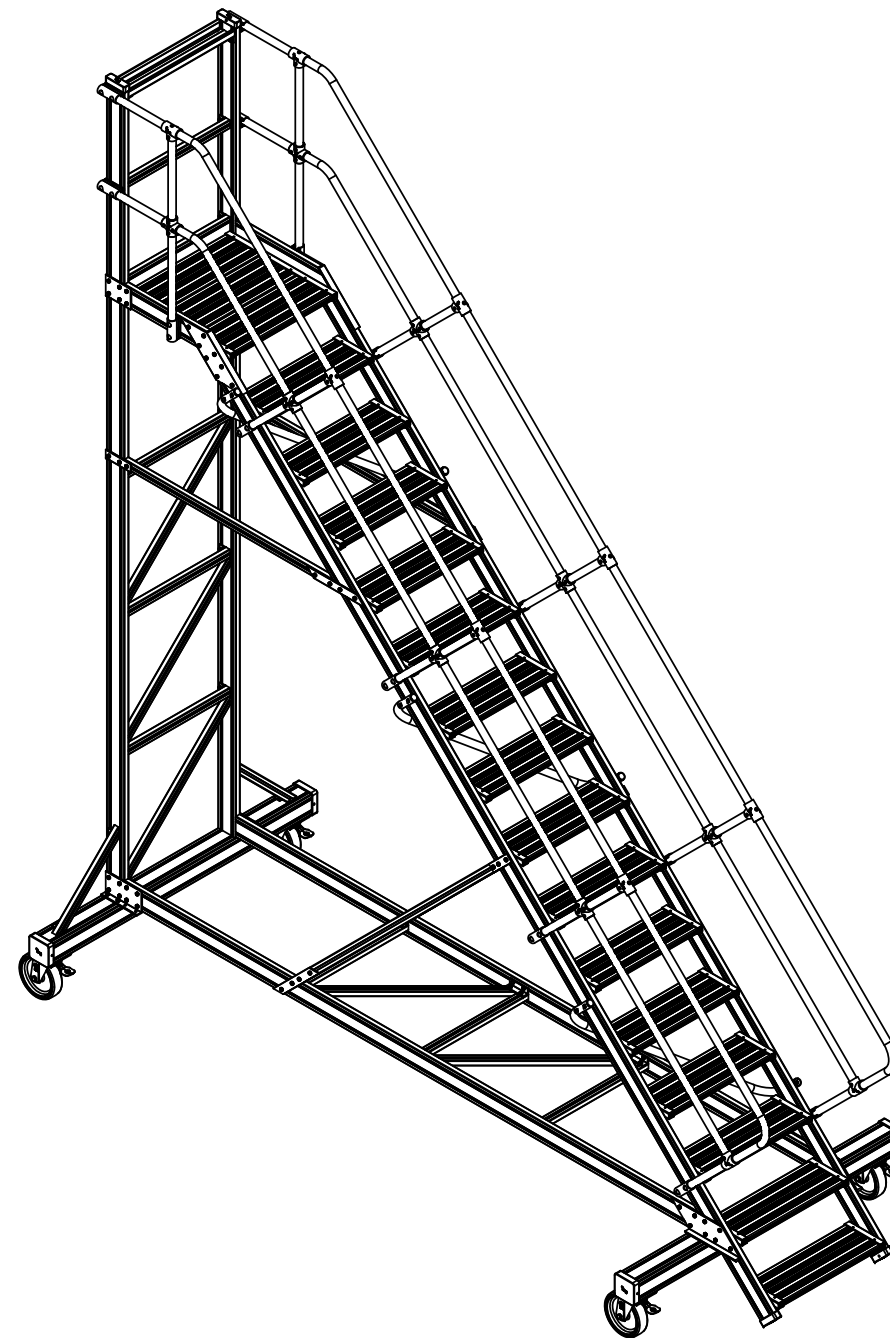
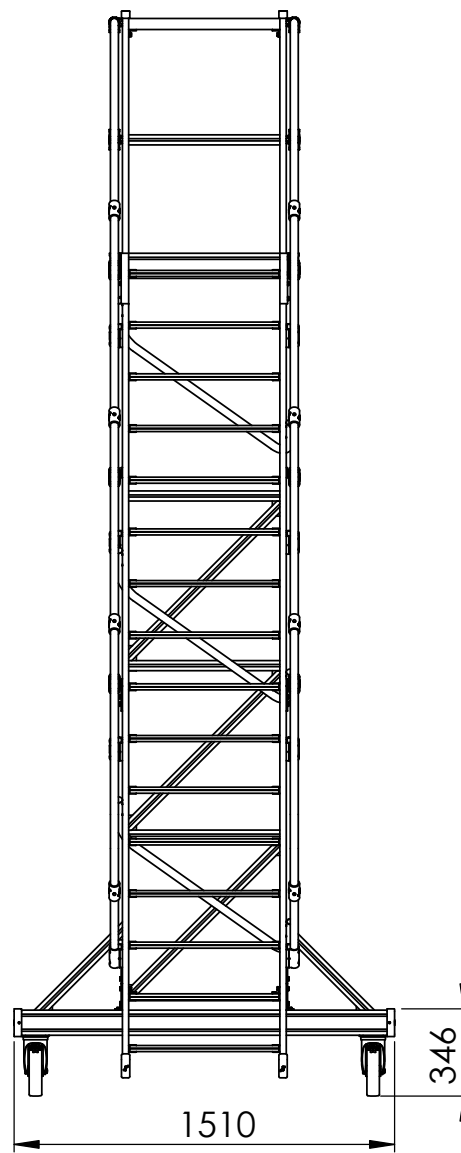
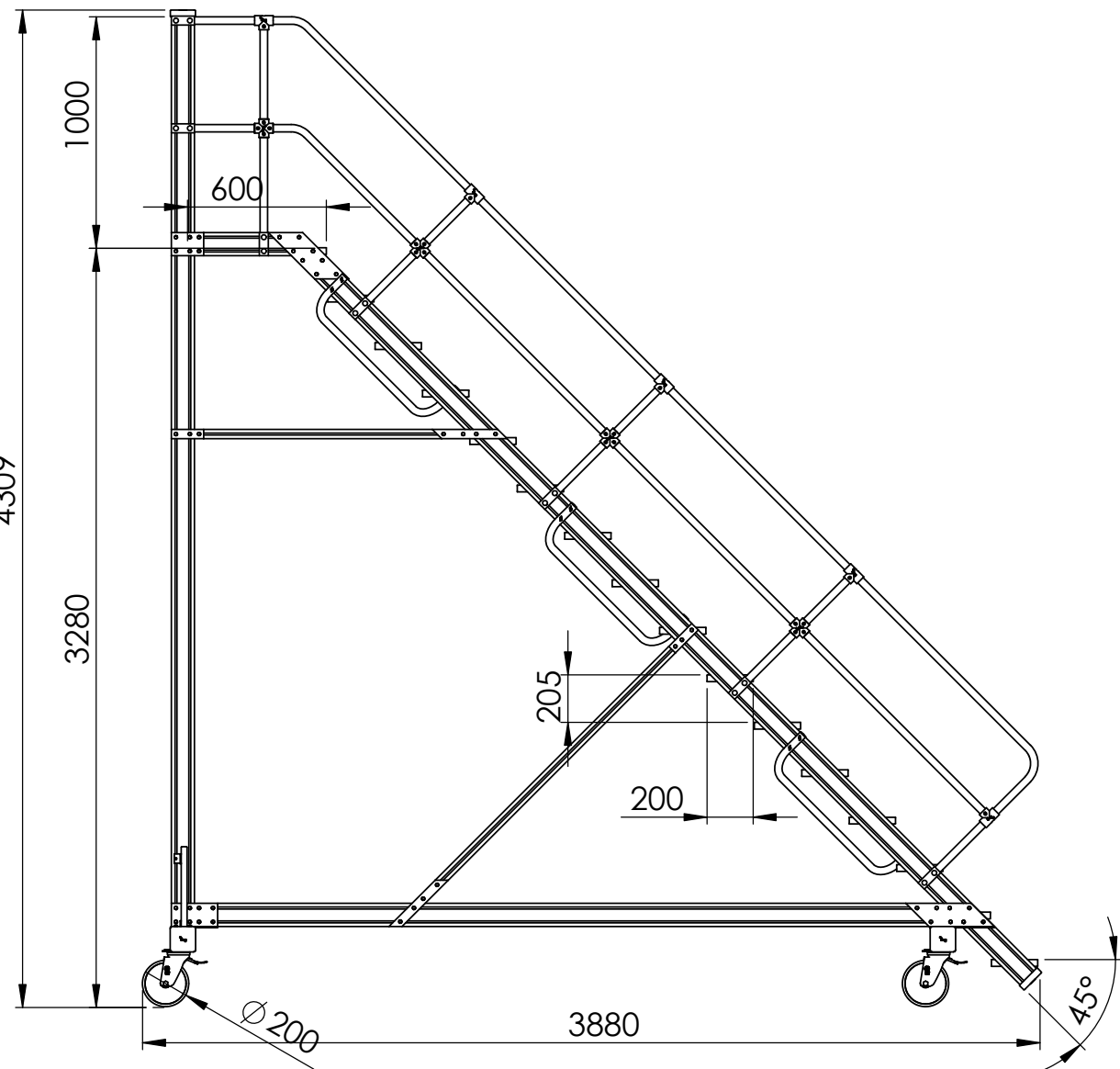
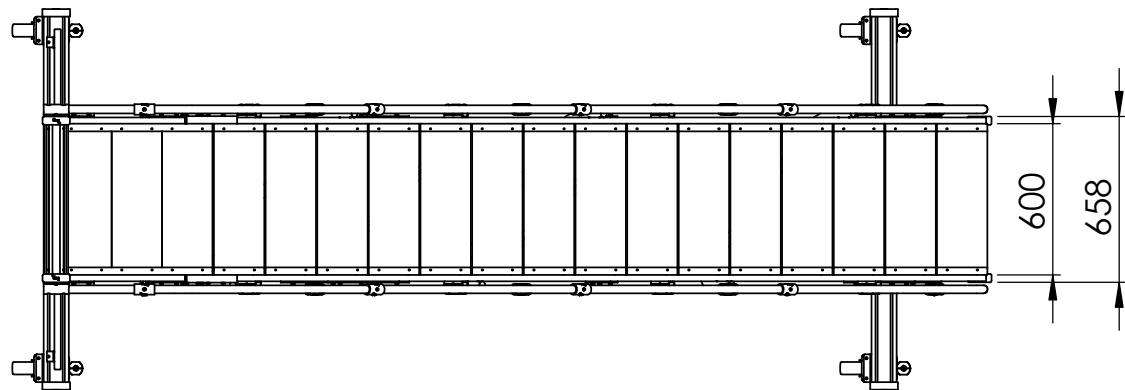

117 Kg

ESLA