

1010014

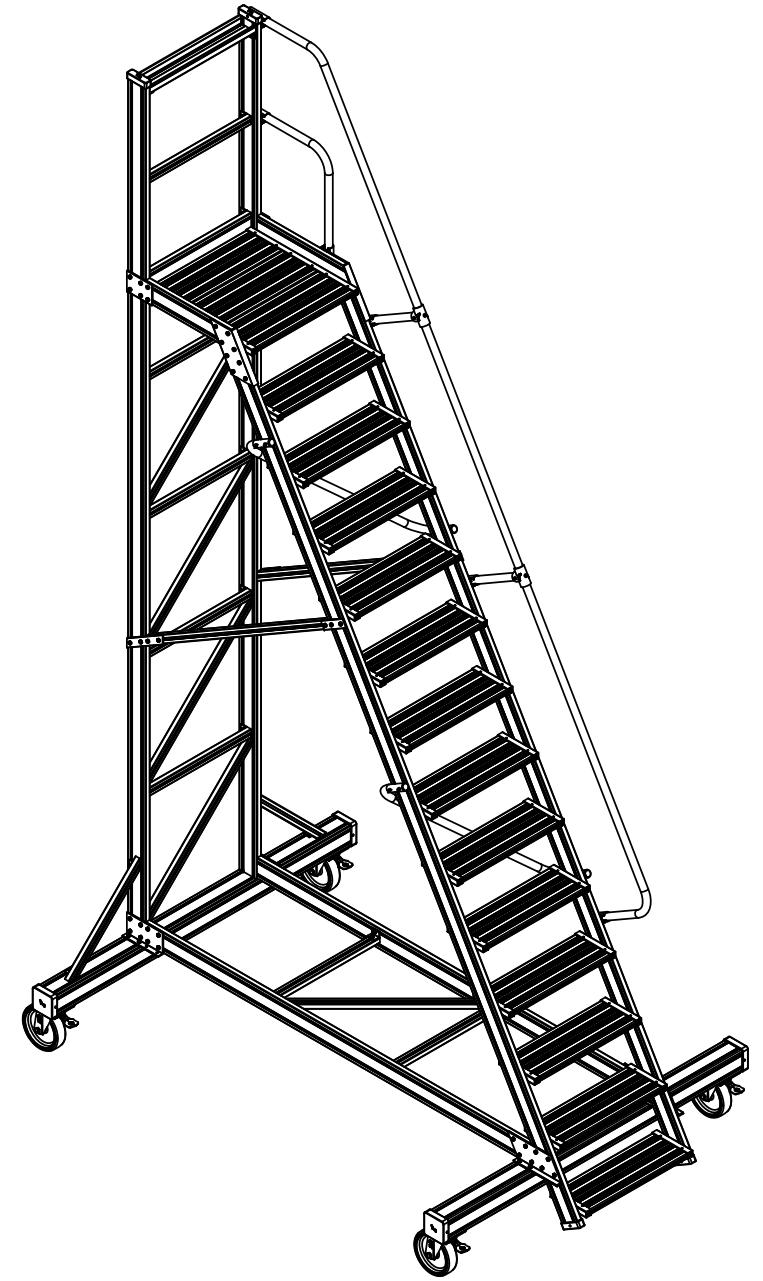
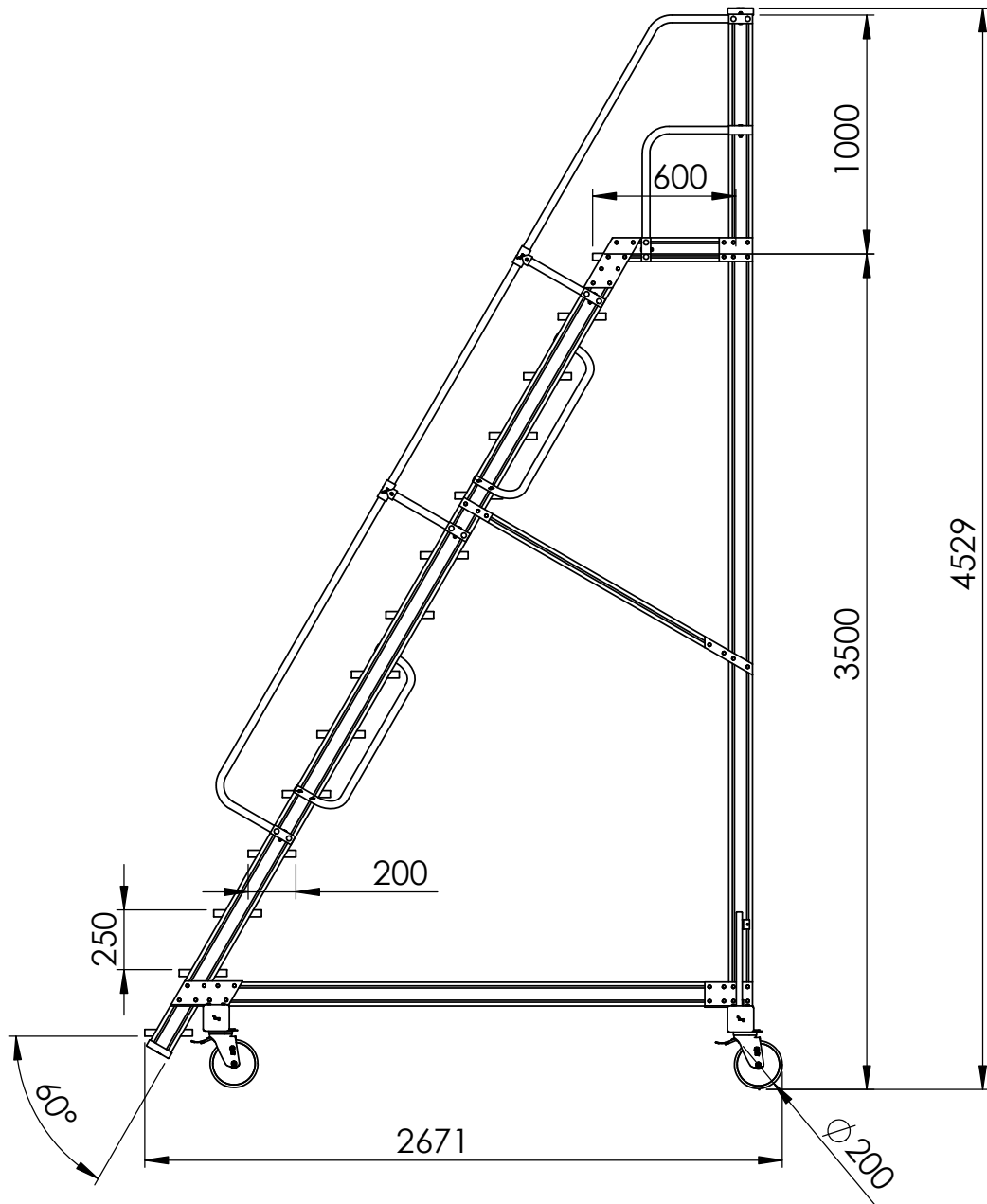
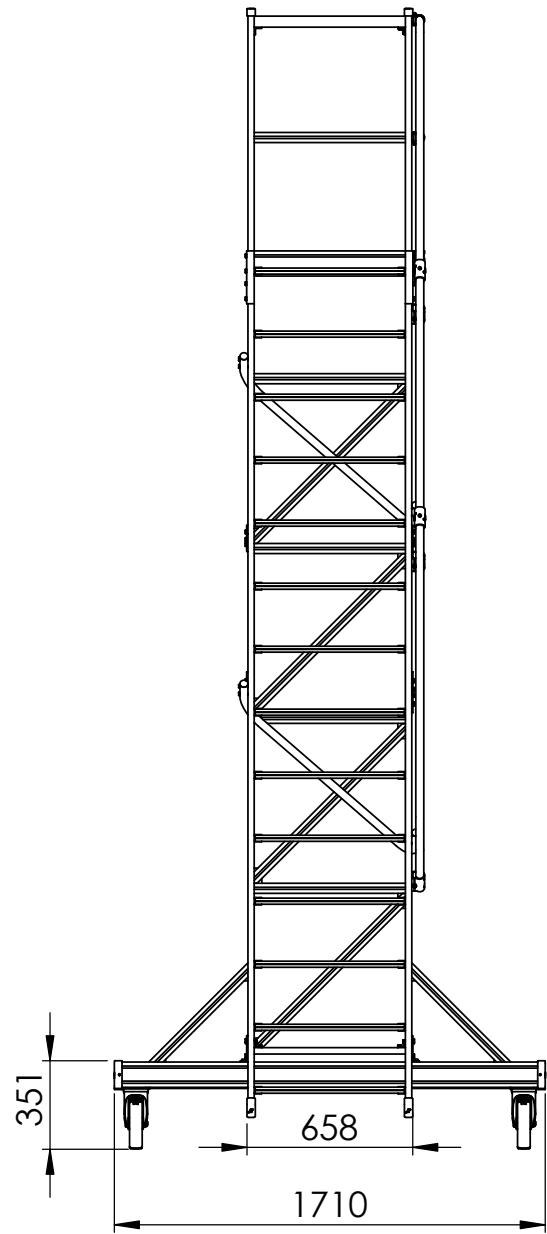
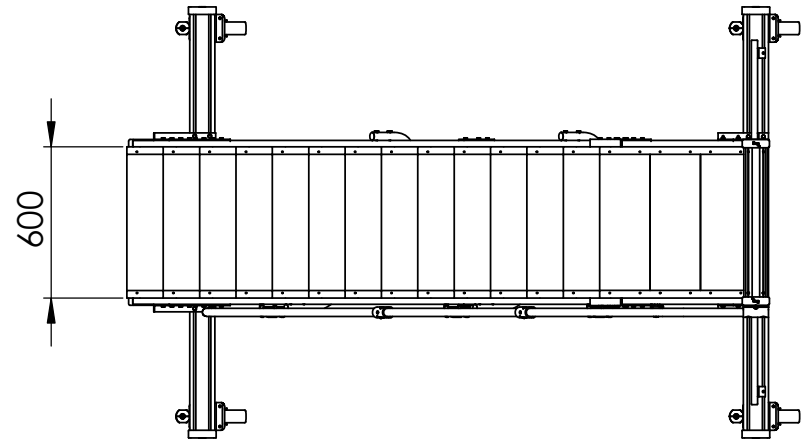

89 Kg

ESLA

1010014DB

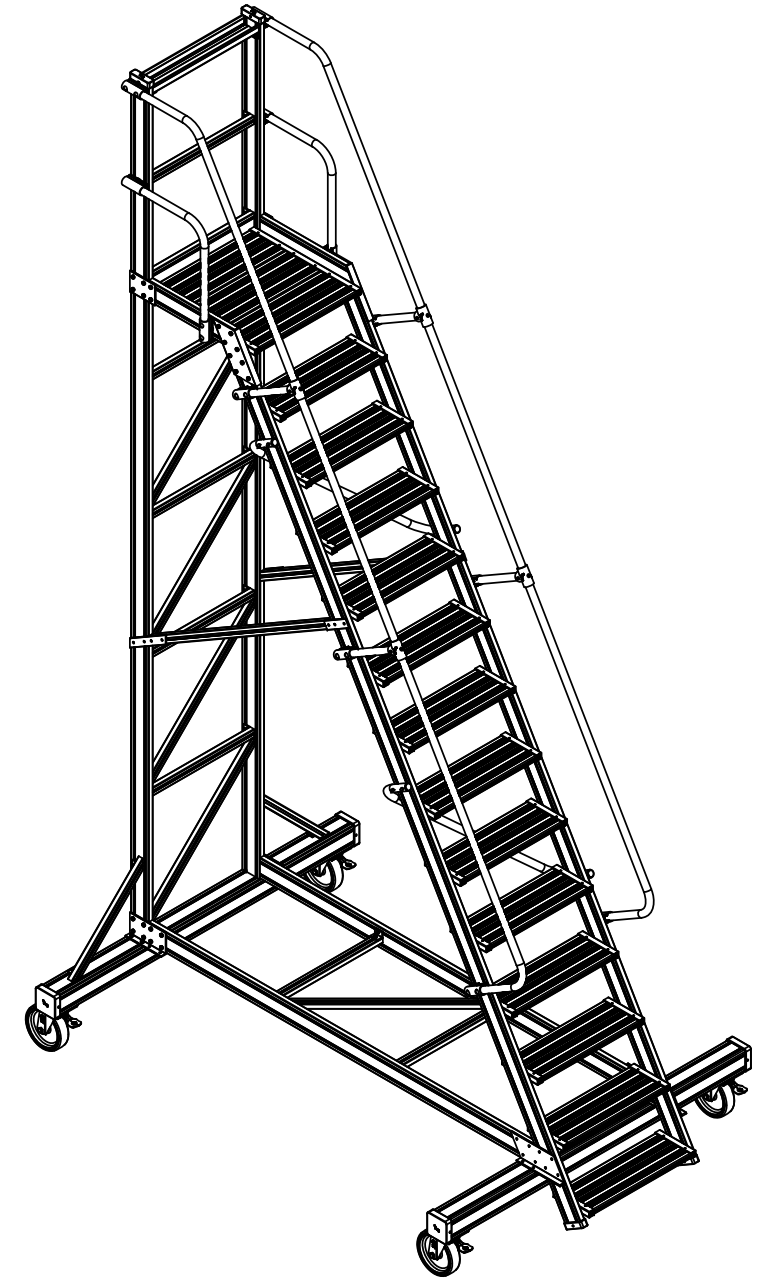
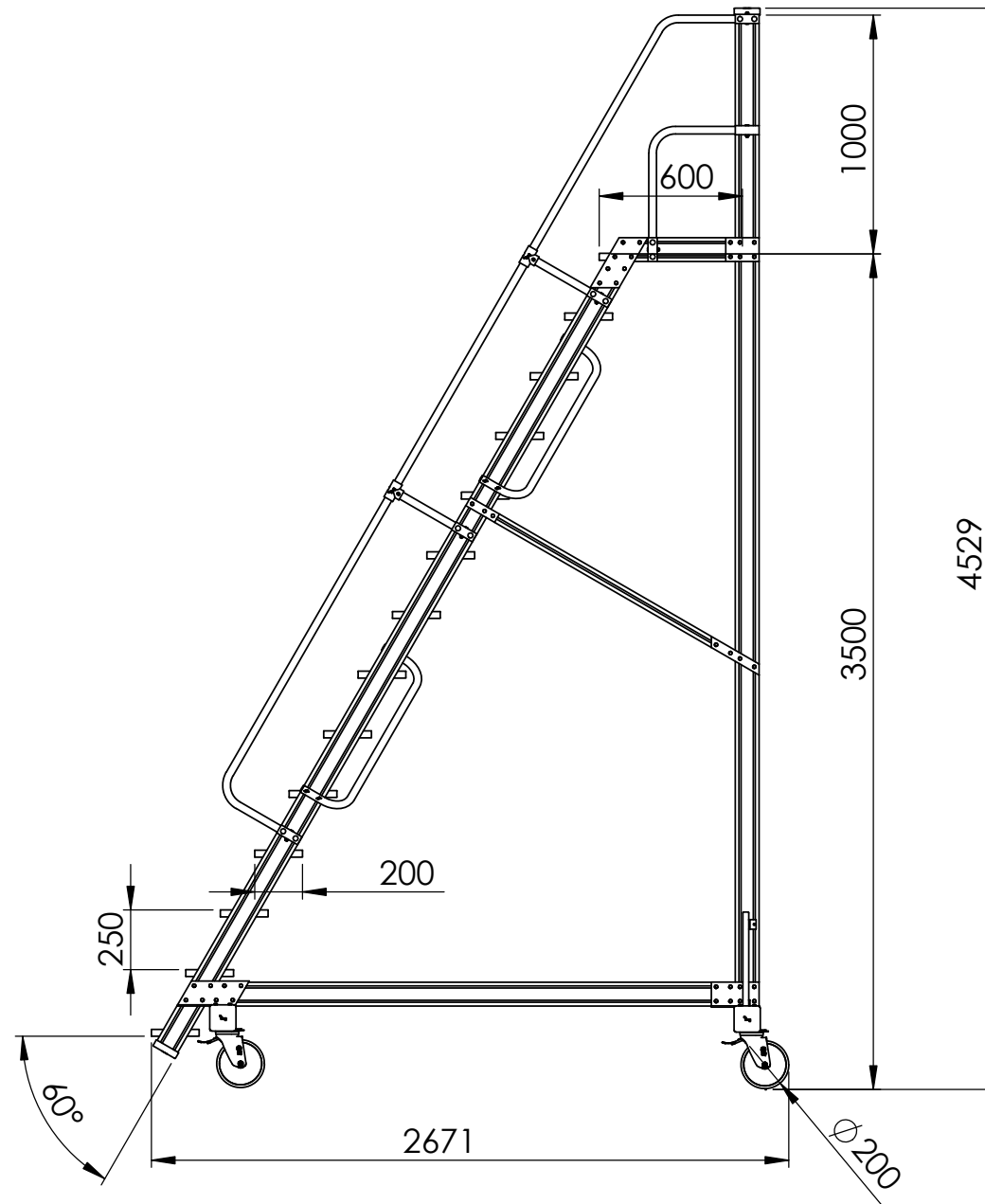
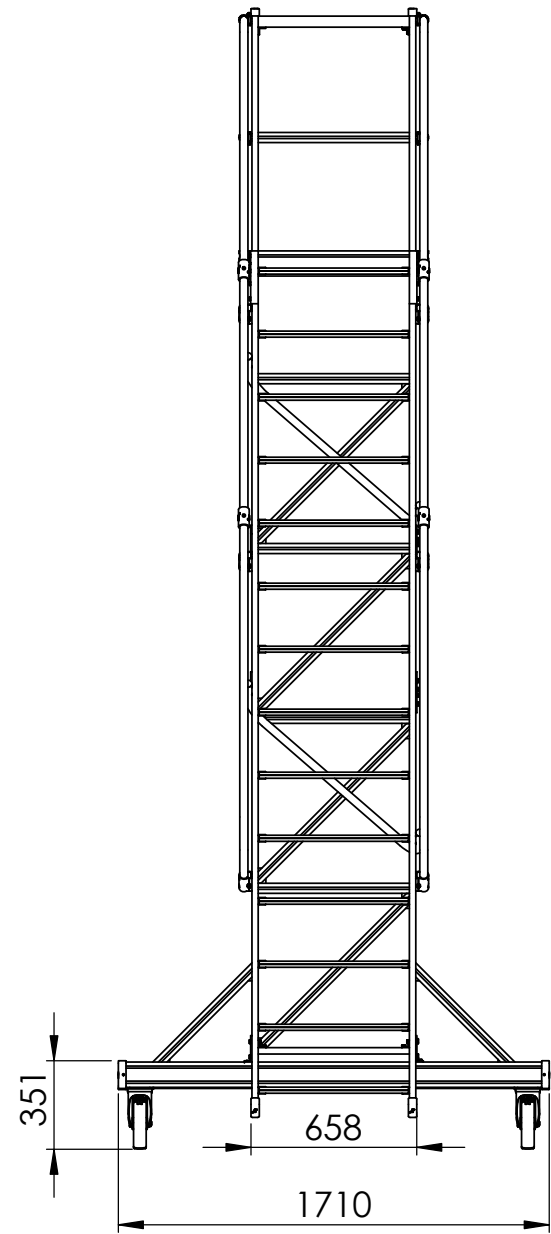
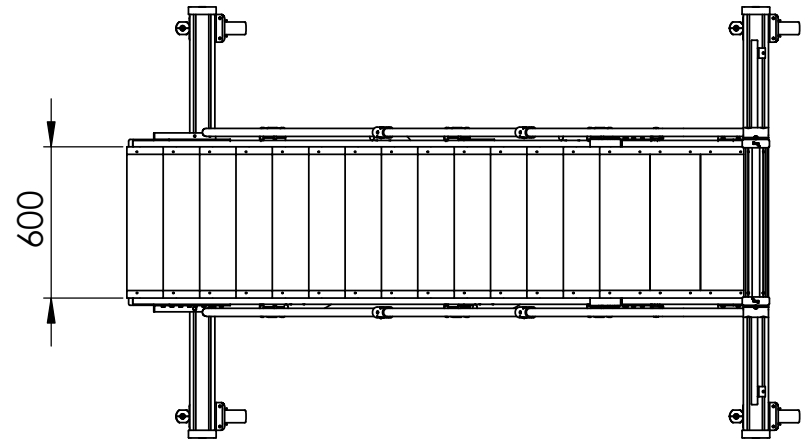

93 Kg

ESLA